



PKfokam Institute of Excellence  
P.O. Box: 11646 Yaoundé/Cameroon

Tel: +(237)222019027

pkfokam@pk institute.com

[www.pkfinstitute.com](http://www.pkfinstitute.com)



## CONFERENCE REPORT

PKfokam Institute of Excellence

Yaoundé – Cameroon

**Date:** 18 & 19 July 2014

**Topic:** The Conquest and Development of Science and  
Technology

[www.pkfconf.org](http://www.pkfconf.org) , [info@pkfconf.org](mailto:info@pkfconf.org)





Our objective is to bridge the gap between theory and practice. We concentrate our effort on aspects that are lacking in the promotion and development of activities relating to the field of Research, Science and Technology in Africa. Our target audience are Engineers, Researchers, Scientists, Entrepreneurs and Industrialists. Amongst other things we are looking at issues such as:

- ❖ The promotion of new technologies or equipment that can support Research Institutions.
- ❖ The highlighting of activities relating to the development of Research to support the industries in Africa.
- ❖ The role of Engineers and Scientists as key players in industrial development.
- ❖ Efforts to establish close collaboration relationships between Engineers, Scientists, Universities and Industrialists in Africa.

Over the past four years we hosted four successful conferences in Berlin, Germany.

- The first conference, **“The state of Science and Technology in Africa, 50 years after independence”** was organized on the 16th of April 2011. This conference pointed out that for the past 50 years, Science and Technology remained a neglected area on the continent. For this reason African Scientists and Engineers have been called upon to put value to their acquired knowledge. They have to find ways to impact on their societies through the transfer of these sciences and technologies.
- The second conference, **“Science and technology in Africa in the 21<sup>st</sup> century: what action to be taken”** was held on the 31st March 2012. The conference aimed at preparing Engineers and Scientists to take action in their various fields.
- Our third conference, **“African Engineers, Scientists, Entrepreneurs and Industrialists for Technology transfer in Africa”** was held on 12 & 13 April 2013. This conference strongly recommended that *« Beside volunteer work done by the Diaspora in Africa, African Engineers & Scientists should create enterprises that can provide jobs and therefore enhance the capacity of the continent to control technologies »*

- Our fourth conference, **“What has Patent sales and Licensing transactions to do with technology transfer in Africa”** was held on April, 12 2014. The exploitation of various existing patents and licenses to boost the industrialization was highlighted

The organization of our fifth conference in Africa, Yaoundé - Cameroon, derives from the remarks of our third conference. Our intention is to encourage and support Engineers and Scientists of the African Diaspora, to enter into partnership with counterparts in Africa and use their knowledge to create enterprises including those in high technologies.



### **The PKFokam Institute of Excellence to Host the conference**

The choice of the PKFokam Institute of Excellence in Yaoundé-Cameroon to host our first African conference is extremely important. Their philosophy encapsulates the idea of Excellence and allows it to be the real catalyst for technological development in Africa. This first conference in Africa will lead to the creation of a framework to support the industrialization of the continent. It will become annual, and the PKFokam Institute of Excellence will be the centre of excellence for accompanying the transfer of technology in Africa.

Thank you to all participants. The second edition will take place on the 9, 10 and 11 June 2015

Dr. Nestor Kamdem

### **The coordinator of the conference**

**18 July 2014 Day 1**

08:30 - 09:45 *Registration + Coffee and Tee*

09:45-10:15 **Welcome words of the rector of the PKFokam Institute of Excellence**  
*Prof. Dr. Jean Wouafo Kamga*

10:15 – 10:30 **Introduction of the conference by the dean of the Faculty of Science & Technology**  
*Prof. Dr. Thomas Njine*

**Session I Chair: Prof. Dr. Thomas Njine**

10 :30 – 11:15 **Dr. Nestor Kamdem , Forschung Molekulare Pharmakologie, Berlin**  
*Topic: Technology transfer? what's that?*

11 :15 –11 :45 **Dipl-Ing Jacques Tene Takou, RUAD – EURD Group, Mechanical Engineering**  
*Topic: Practical example of technology transfer : Mechanical Engineering*

11 :45 – 12:15 **H.E. Prof. Dr. Maurice Tchuenta**  
*Topic: Research Methodology*

12:15 – 14:00 **Lunch**

**Session II Chair: Benjamin Boum**

14 :00 –14 :30 **Engr. Michael Teoua, The REC Group**  
*Topic: Understanding of the technologies and their applications*

14:30 – 15:00 **Mr Kennedy Tumenta , AfricanBIB**  
*Topic: Promoting Ethical entrepreneurship and transfer of Integral knowledge*

15:00 – 15:30 **Engr. Stephane Ekobo, Technorex Group :**  
*Topic: Technorex technology*

**July 19 2014 Day 2**

**Session III Chair : VOX AFRICA**

10:00 - 11:00 *Documentary Film Energy & Research*

11 :00 –12 :30 **Round table**  
**Topic:** *Commitment of the African Engineers & Scientists to catalyze the Technology Transfer: The challenges?*  
*Panelists: Stéphane Ekobo, Benjamin Boum ; Aristide Baho*

12:45 *Closing ceremony*

## Welcome words of the Rector of the PKFokam Institute of Excellence

**Prof. Dr. Jean Wouafo Kamga**



Bonjour à tous et bienvenu à la PKFokam Institute of Excellence. Nous sommes évidemment très fier d'abriter une telle conférence sur le thème général de transfert de Technologie parce que le sujet est extrêmement important pour notre pays. Et lorsqu'on aborde un tel sujet, on ne peut pas ne pas se poser des questions de type : Quel environnement pour un transfert réussit.

## Introduction of the conference by the dean of the Faculty of Science and Technology of the PKFokam Institute of Excellence

**Prof. Dr Thomas Njine**



Parlant du transfert de technologie, il faut dire que ce n'est pas un thème nouveau. C'était même un thème favori des années 80-90. Le sujet est très vaste et il couvre beaucoup de domaines en réalité. Le transfert de technologie fondamentalement est le processus qui désigne le transfert formel à l'industrie de découvertes résultantes de la recherche universitaire ou privée dans le but de les commercialiser sous la forme de nouveaux services. Et c'est bien dans ce sens que nous universitaires et chercheurs ici aujourd'hui nous entendons transfert de technologie, c'est à dire l'intervention des résultats de la recherche dans le développement.

**Dr. Nestor Kamdem**  
**Leibniz-Institute für Forschung Molekulare  
Pharmakologie Berlin**  
**Topic: Technology Transfer? What's that?**



## 4 Conferences to support the Idea of Science and Technology Transfer in Africa have been organized since 2011

---

### 1-

**Topic:** The state of Science and technology in Africa, 50 years after independence

**Date:** 16-04- 2011

**Place:** Technical University of Berlin, Germany

### 2-

**Topic:** Science and Technology in Africa in the 21st century: what action to be taken?

**Date:** 31-03-2012

**Place:** Technical University of Berlin, Germany

### 3-

**Topic:** African Engineers, Scientists, Entrepreneurs and Industrialists for Technology transfer in Africa”

**Date:** 12 & 13 April 2013

**Place:** Technical University of Berlin, Germany

**This conference strongly recommended:**

*« Beside volunteer work done by the Diaspora inside the continent, African Engineers & scientists should create enterprises that can provide jobs and Therefore, enhance the capacity of the continent to control technologies »*

### 4-

**Topic:** Patent sales and licences transaction

**Date:** 11 & 12 April 2014

**Place:** Technical University of Berlin, Germany

# Dangers Inherent to a country with zero technological growth

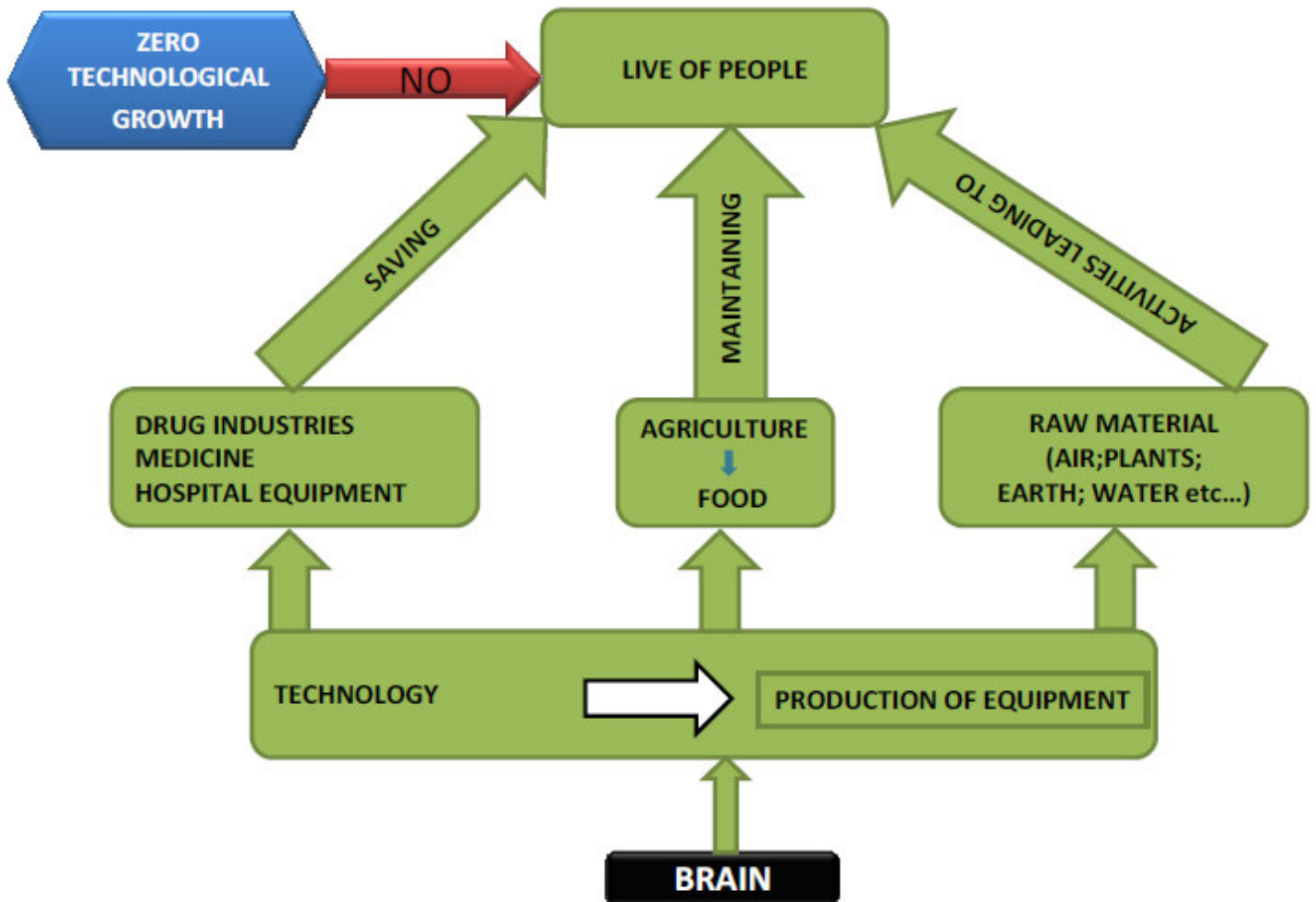

**Brain gain will help Africa to master technologies, and avoid zero technological growth. Therefore, enhanced economical growth**



## Negative effect of zero technological growth



### Sign of poverty in Africa? Maybe?

No production in Africa!!!

Importation of very old materials and equipment!!!

Maintenance problem!!!

No recycling technology!!!

Environmental problem???

**Think about it!!**

**To me, it is clear that increasing poverty and wars in African countries are simply due to the lack of scientific knowledge and Technology that enable African countries to solve their elementary and primary problems**

**African Governments, Decision makers, African entrepreneurs', African Engineers, African Scientists, Please, together let's stop this kind of image**

Dr. Nestor Kamdem

# State of Science & Technology Before and after independence

---

1- S&T is largely influenced by the needs of the people. They study the matter around them and use it.

2- People from different region have developed their own S&T, which is now called indigenous as opposed to the current modern technology.

In 1960, Governments make strong policy statements in favour of Science and Technology As foundation for socio economic development.

-Creation of Research staff, Research Agencies,

-Universities Institutions

## The death of Modern Science and technology in African countries

---

**1980:** The declaration of IMF and other stakeholders saying that scientific research And Higher education are not priority sectors for Africa

### Direct Consequences

The decrease of budgets devoted to science and technology. In some countries, some research institutions were even closed. Salary cut and freezing of recruitment of the research staff

Curiously, governments which had invested huge amount of money in science and technological institutions could have tried to use science and technology as tool to solve the economic crisis. Unfortunately, they rather accepted without Great resistance the theory developed by multilateral stakeholders and which was simply the renunciation of science.

Dr. Nestor Kamdem

# Technology Transfer: Proposed Schemes

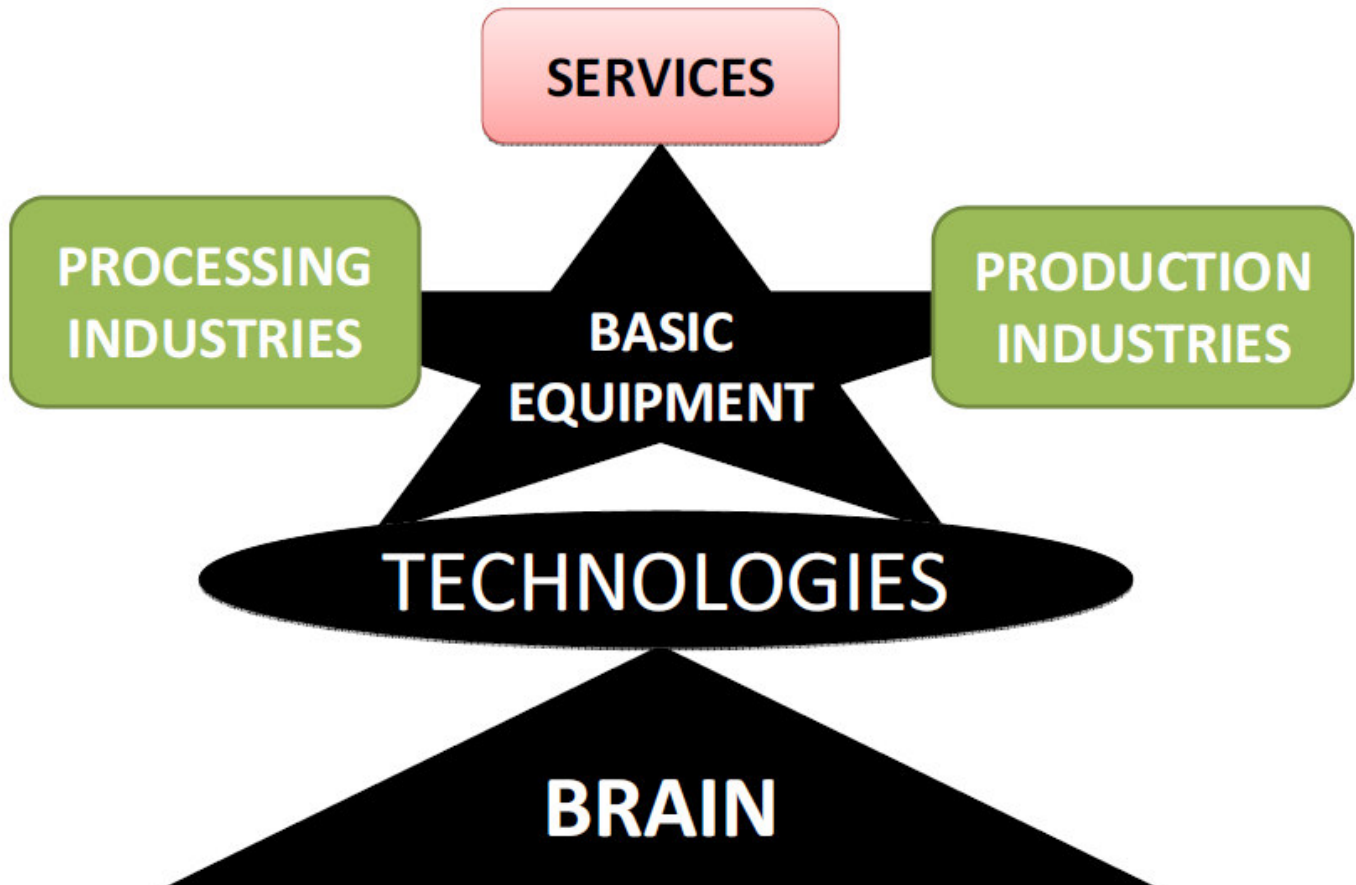

Only societies, whose cultures commit them to successful technological progress as a policy of practice, are qualified to survive and to prosper. With the following diagram, we try to demonstrate the benefits of mastering science and technology for human life in any society. Non-mastery of science and technology lead to the abolition of life. African countries should avoid brain drain and foster brain gain.

Dr. Nestor Kamdem

## Know-How from Scientists and Engineers to the market-I

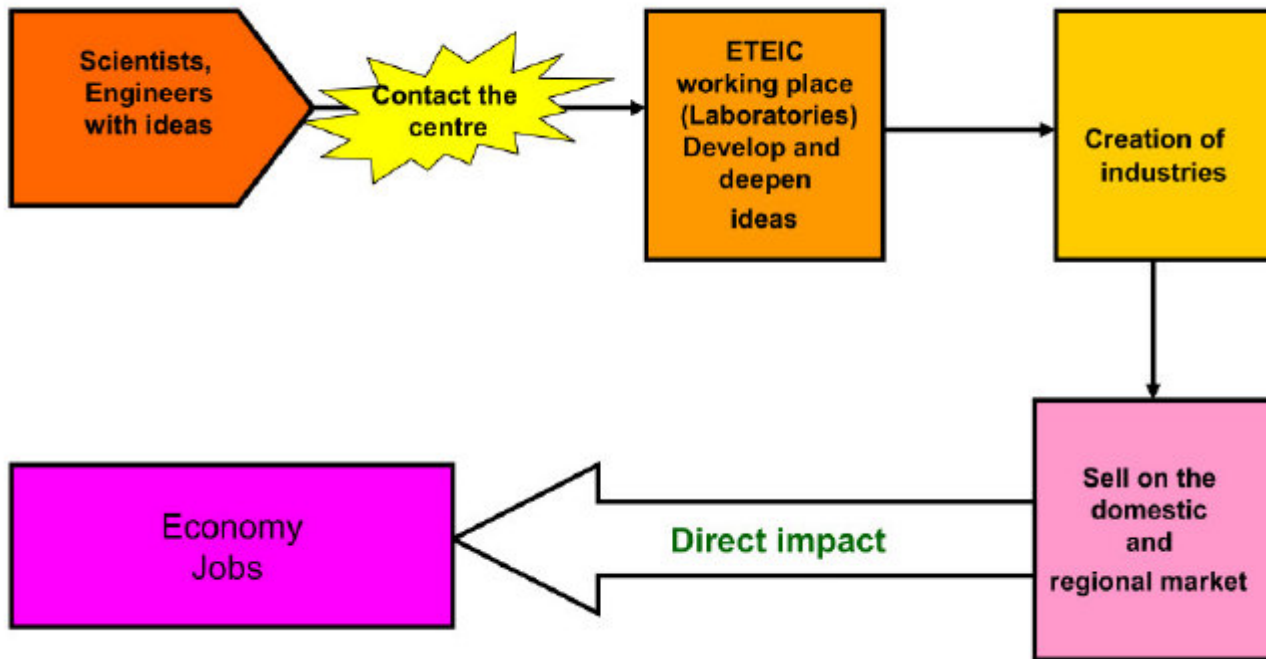

## Transform the idea of people via scientists and Engineers to the market

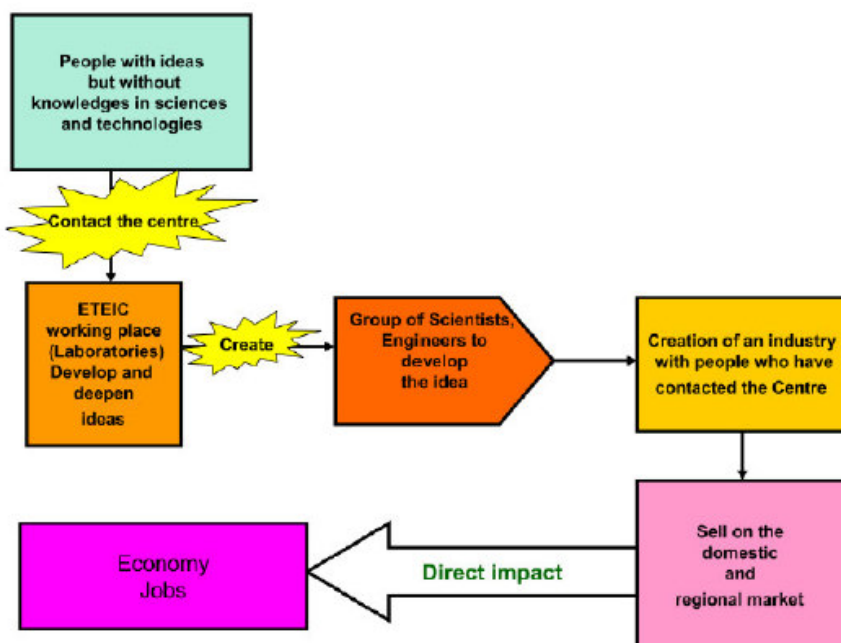

## Strategies for Maintenance and/or Production of equipment

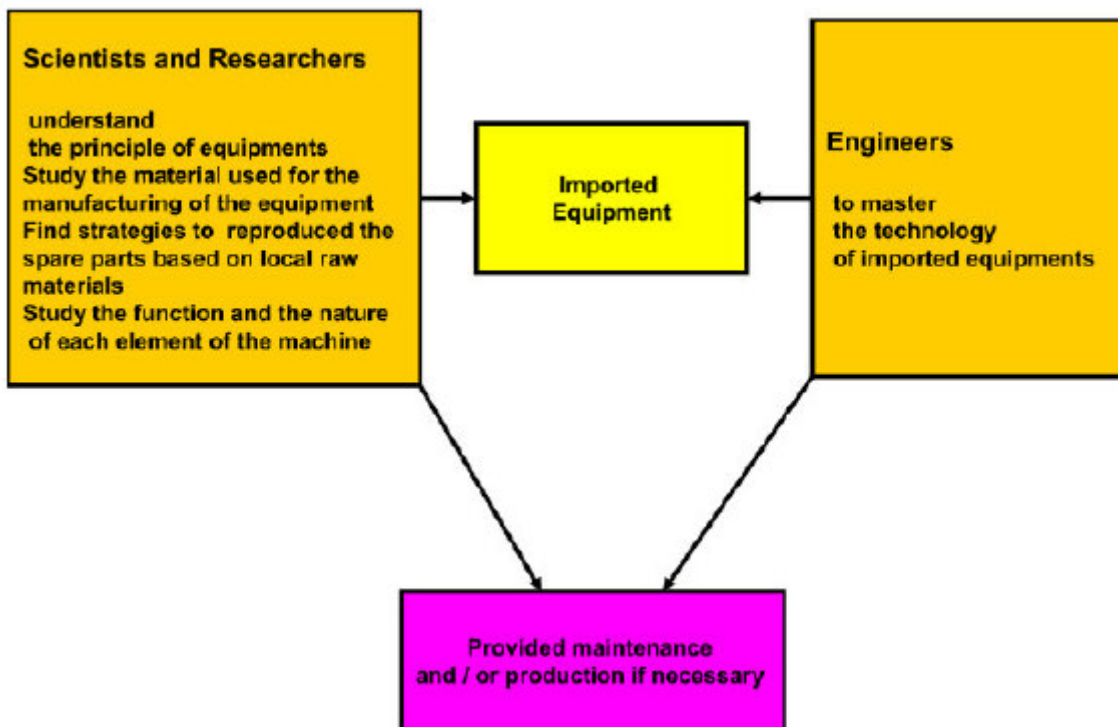

## Transformation of knowledge into practice = Technology Transfer

ACQUIRE THE NECESSARY KNOWLEDGE WHEREEVER YOU CAN,  
AND TRANSFORM IT INTO PRACTICE

MAKE VISIBLE YOUR KNOWLEDGE BY SOLVING PRACTICAL  
PROBLEMS OF THE SOCIETY

Is not that the technology transfer? Of course that's the  
technology transfer

Dr. Nestor Kamdem

**Dipl-Ing Jacques Tene Takou**

**RUAD-EURD**

**Mechanical Engineering group**

**[www.ruad-eurd.org](http://www.ruad-eurd.org)**

**[info@ruad-eurd.org](mailto:info@ruad-eurd.org)**

**Topic: Practical example of technology  
transfer: The centrifugal pump**



# Outline

---

## I. Motivation

## II. Fluid Machines

- **Types of pumps**
- **Components of a centrifugal pump**

## III. Technology and technology transfer

## IV. The construction

- **Characteristics**
- **Design**
- **Simulation**

## V. The Team

## MOTIVATION

---

- Lack of water
- Rain water storage
- Collect of water in a high located cistern or tank
- Use of the pressure energy to supply equipments

(flushing, water tape...) in household

- Pumps are the most important device in industries

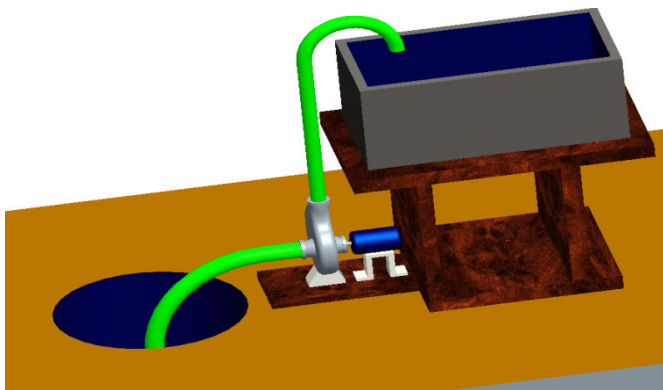

## FLUID MACHINES

---

**Turbines** – The turbines extract energy from the fluids

**Pumps** – They add energy on the fluids

Devices that are used to extract or to transmit liquid from a source to another location (PUMPS)

There are two basics types of pumps:

- Positive-displacement pumps
- Dynamic pumps



# FLUID MACHINES

## Basic types of pumps

### Positive-displacement pumps

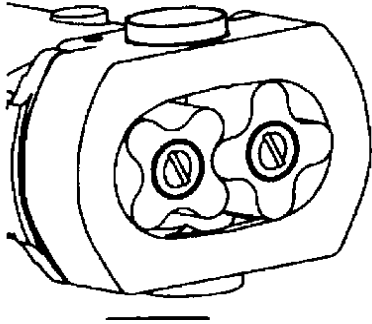

### Kinetic pumps

## BASIC COMPONENTS OF PUMPS

### Impeller

#### Rotating component

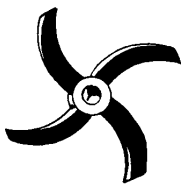

Open

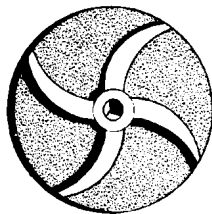

Semi open

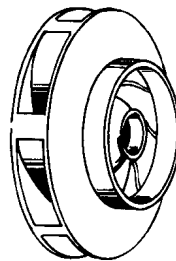

Closed

### Housing/Casing



### The coupling

The force to drive the fluid out of the housing comes from the driver.

# TECHNOLOGY AND THE TECHNOLOGY TRANSFER

---

## THE TECHNOLOGY

Technology can be thought of as the system of knowledge, skills, experience, and organization used to produce and utilize goods and services to satisfy human demand for sustenance and comfort.



## THE TECHNOLOGY TRANSFER

Technology transfer is the process whereby technology is moved from one physical or geographic location to another for the purpose of application toward an end product.

### Technology Transfer classifications

- Material transfer
- Design transfer
- Capacity transfer

# OUR CONSTRUCTION

---

## CHARACTERISTICS OF THE PUMP

Power: 5,5 kW

Efficiency: 45%

Water temperature: 40°C

Pump capacity: 3,5 l/s

Main Material: gray iron

Head: 20 m

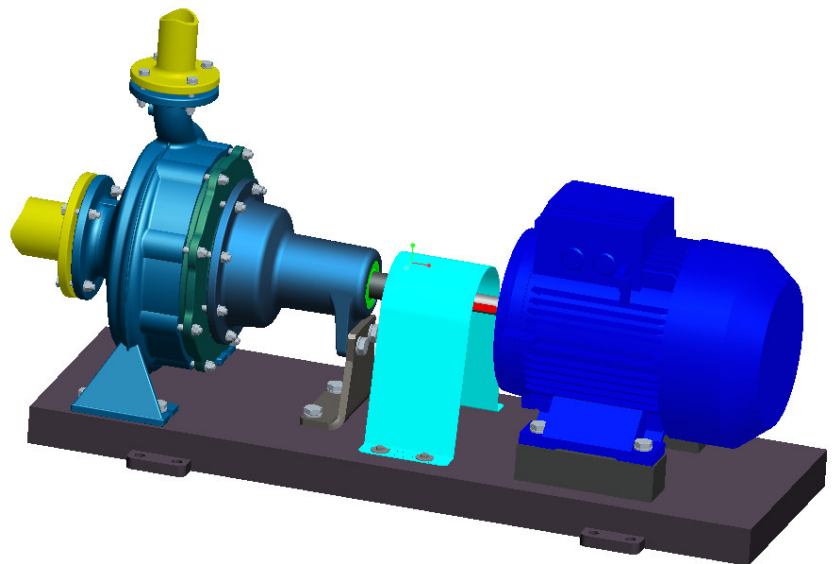
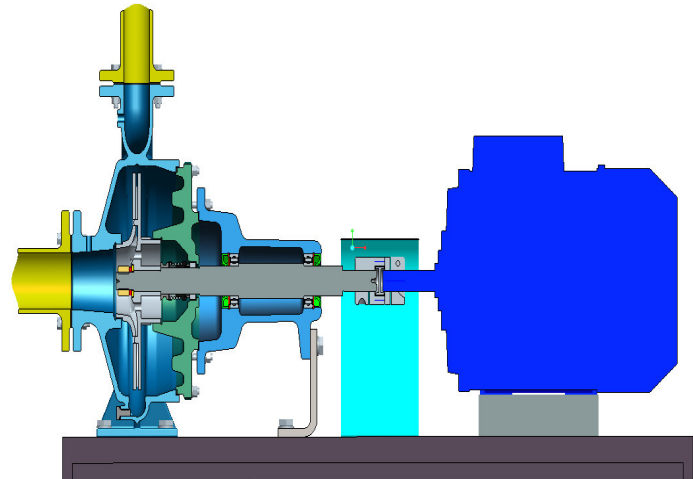

---

Dipl-Ing Jacques Tene Takou, RUAD-EURD Group

**HE Prof. Dr. Maurice Tchuenté**  
**Former Minister of Higher  
Education, Cameroon**  
**Topic: Research Methodology**



# Starting the Point for a Thesis

---

- A Question
- +
- An approach Responsibility of the Supervisor!

## Analysis of the question

---

- Thematic task
- Usual analysis scheme  
(Information systems, ...)
- Tools: articles, books, reviews
- Output: Specific precise questions

## State of the art (approach)

---

- What is known on related models together with their weaknesses % the question
- Tools:
  - Research papers (reviews, recent, reference)
  - Books (reference, monographs)
- Output: A reference model

# Modelling Scheme

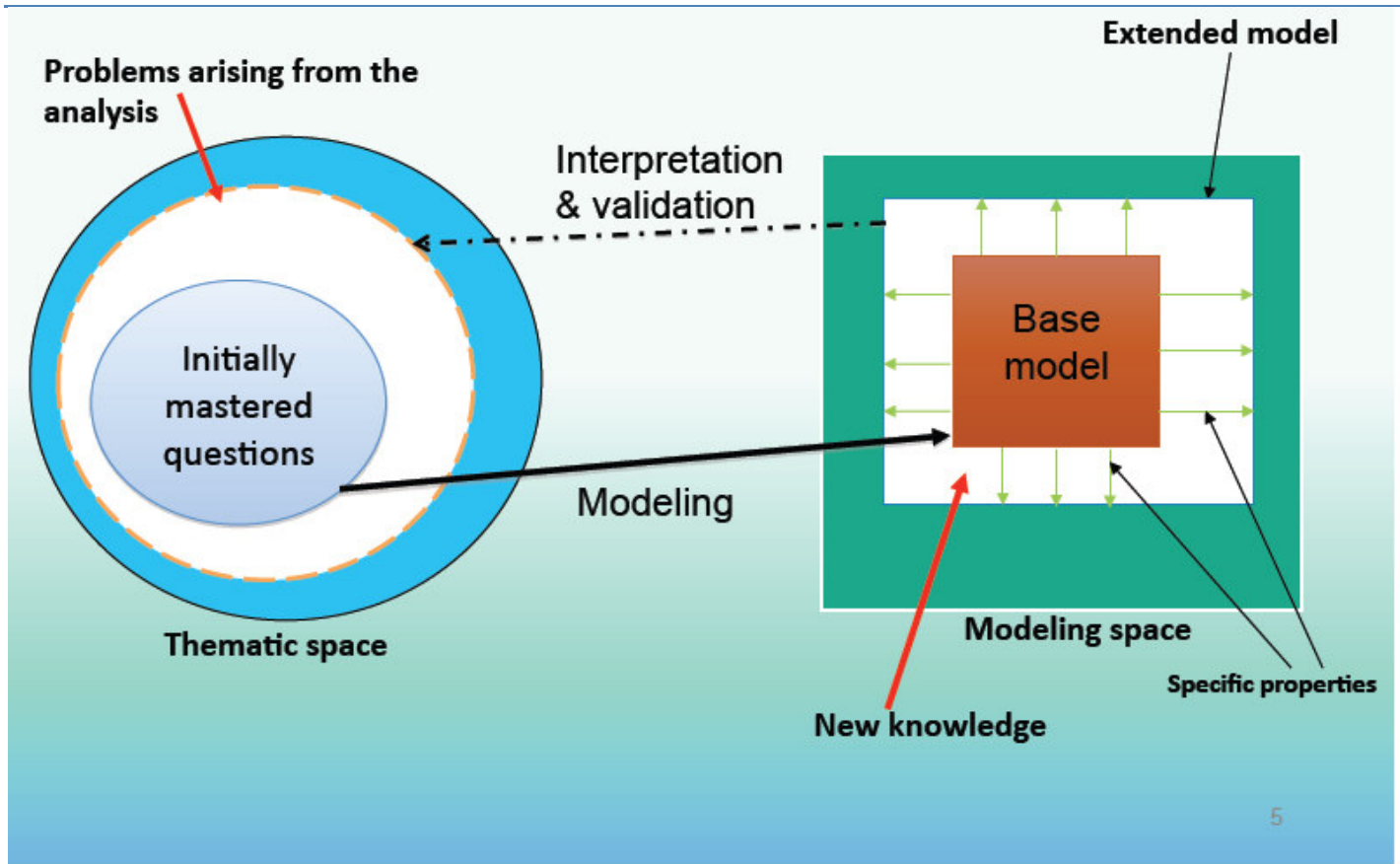

## Example: RDF

**Question:** Description of web resources

**Idea:** RDF triples (Subject, Predicate, Object)

**Model:** RDF graph



**Triples:** assertions in a logical system

**Internal property:** the system is **open**

# Examples

---

## Example 1

**14 décembre 1871 : Renan : « Une race de maîtres et de soldats, c'est la race européenne. » (France)**

Ernest Renan écrit après la défaite en 1871 dans *Réforme intellectuelle et morale* : « Une nation qui ne colonise pas est irrévocablement vouée au socialisme, à la guerre du riche au pauvre ».

*La conquête d'un pays de race inférieure, par une race supérieure, qui s'y établit pour le gouverner, n'a rien de choquant... Autant les conquêtes entre races égales doivent être blâmées, autant la régénération des races inférieures par les races supérieures est dans l'ordre providentiel de l'humanité.*

*L'homme du peuple est presque toujours chez nous un noble déclassé; sa lourde main est mieux faite pour manier l'épée que l'outil servile... Versez cette dévorante activité sur des pays qui comme la Chine, appellent la conquête étrangère... chacun sera dans son rôle.*

*La nature a fait une race d'ouvriers; c'est la race chinoise, d'une dextérité de main merveilleuse sans presque aucun sentiment de l'honneur... gouvernez-la avec justice... elle sera satisfaite; - une race de travailleurs de la terre, c'est le nègre, soyez bon pour lui et humain et tout sera dans l'ordre; - une race de maîtres et de soldats, c'est la race européenne. »*

## Example2: Politique

*Communication Politique :*

*Question : de nature politique*

*Modèle : emprunté au Marketing*

*Corruption Politique :*

*Question : de nature politique*

*Modèle : emprunté au Commerce (on achète tout !)*

# Road Map

---

1- After one year: Project Defence (Conf)

- Context
- Problem
- State of the art
- Model

2 - During 18 months (paper in Journal)  
Development of the model Validation

3 - During six months: writing (thesis)

# Skills to Acquire

---

**Research: Local (Focus, Laser) New knowledge**

**Teaching: Global (Basements, Projector) Broad and Deep Knowledge**

**Expertise:**

**Transversal (Applications) Uptodate Technologies**



# Research Organization and Strategy

---

## Research method in Social Sciences

C'est la procédure logique d'une science, c'est-à-dire l'ensemble de ces pratiques particulières qu'elle met en œuvre pour que le cheminement de ses démonstrations et de ses théorisations soit clair, évident et irréfutable

(Aktouf O. Méthodologies des sciences sociales et approche qualitative

des organisations, Presses de l'Université du Québec, 1987)

## Research Steps in Social Sciences

- Sujet et Problème de recherche
- Question et Hypothèse (solution présumée)
- Fundamental (academic)
- Applied (utilitarian)
- Technological (Developmental)

## Types of Research

---

- **Fundamental (academic)**
- **Applied (utilitarian)**
- **Technological (Developmental)**

## Fundamental (academic)

---

- **Context**
- **Question**
- **Problem (Specific question)**
- **Idea (general)**
- **Approach (scientific)**
- **Model (technical)**
- **Model Development**

### Research : Brief History

- **Pre-scientific : isolated scholars (speculative, exploratory)**
- **Scientific : XVI – XIX institutionalization**  
Bacon Master of nature, development of Nations. Royal Soc, Academies
- **1940 - . Professionalization**  
Integrated (policy, economy, defence)

## Research: Actors and Output

---

### Actors

- PhD Students
- Research Fellows
- Engineers and Technicians

### Output

- Publications (cf classification)
- Patents (hardware/software)

# Classification of Publications

---

- ISI Web of Science
- ERA (A, B, C)
- Scopus, Scimago
- DBLP, MathScinet

Fake Journals: [http:// allfakejournals.blogspot.com/](http://allfakejournals.blogspot.com/))

## Funding

### Sources

- Public (national) • Private • International

### Mode

- Recurrent • Project • Contract

## Evaluation

### Level

- Individual (paper, fellow)
- Institution (team, lab, Inst, syst.)

## Indicators

- Production (pub. Patents, reports)
- Impact (techno, strat., soc., com.)
- Perspectives: potential applications

# Road Map for PhD Students

---

## Thesis

- 18 monts: paper Int. Conf.
- 3 years: paper Journal (Defence) Leadership
- 3 years: One project funded Impact
- Teaching (course material)
- Expertise (software – patent)

## Conclusion: Be Strategic

---

**Swot Analysis** (A.S Humphrey 1960) Strengths – Weaknesses  
Opportunities – Threats

### Can be used for

- "kick off" strategy formulation
- Strategy design
- Evaluation

## SWOT Matrix

	<b>Positive</b>	<b>Negative</b>
Internal	Strengths	Weaknesses
External	Opportunities	Threats

**Strengths:** controlled basement on which to build the future  
**Weaknesses:** controlled with important improvement potential

**Opportunities:** exploitatble for devmt current stren. & weakn.  
**Threats:** pbs, obstacles limitations against devmt

## Exploitation of SWOT Matrix

		<b>Str</b>	<b>Wkn</b>	
		Max Str	Min Wkn	U.S ms wk
Opp.	Max Op			
Threats	Min Threats		Min Wkn Th?	
U op red th				

Use Str to Take adv of Opportunities

Correct wkns Using opp.

Use Str To reduce Threats

Minimize Wkns & threats

## Homework

---

Do the swot analysis for your Team

**Engr. Michael Teoua**

**REC group**

**[www.rec-rec.org](http://www.rec-rec.org)**

**[rec@rec-rec.org](mailto:rec@rec-rec.org)**

**Topic: Understanding of technologies  
and their applications**



## Outline

---

- ◎ WHO ARE WE?
- ◎ OUR GOAL
- ◎ OUR DOMAIN
- ◎ ACHIEVEMENTS
- ◎ TOOLS
- ◎ EXPECTATIONS
- ◎ RESEARCH

# Who we are

---

## ◎ GROUP OF EXPERTS IN VARIOUS FIELDS IN ENGINEERING

- CIVIL ENGINEERS (Road constructions, buildings, bridges, others tanks, fuel stations, water tower...)
- COMPUTERS ENGINEERS
- ELECTRICAL ENGINEERS
- ARCHITECTS
- WOOD AND IRON ENGINEERS (specialisation)

## LECTURERS FROM UNIVERSITY

- ✓ CHEMISTRY
- ✓ MECHANICAL ENGINEERING
- ✓ TECHNICIANS
- ✓ Electricians, Bricklayers, painters, tillers, drivers ...

# Our Goal

---

- RUN AFTER NEW TECHNOLOGIES IN ANY AREA
- STUDY COMPREHEND THEM
- IMPLEMENT ,USE , AND APPLY THEM IN ANY DOMAIN OF OUR COMPETENCY
- DEVELOP AND USE OUR LOCAL MATERIAL



## Our Domain of Competency

---

- BUILDINGS
- ROAD CONSTRUCTIONS
- BRIDGES
- RESEARCH
- TECHNOLOGIES TRANSFER

## Our Achievements

---

- ◎ BRIDGE OF STONES OF 12 x 8 M WITH IPE IN PUMA
- ◎ FIVE BUILDINGS OF THREE STOREYS IN DOUALA
- ◎ EXPLOITATION OF SAND AND GRAVEL IN DOUALA IN NEIGHBOURHOOD CALLED NLOGBESSOU
- ◎ BUILDING IN PROGRESS (nkoabang)

## Our Tools

---

- SOFTWARES IN CIVIL ENGINEERING  
(robot bat, cbs, autocad, archicad, covadis, etc.)  
Study office

## Our Expectations

---

- **IMPACT SOMETHING NEW IN THE CONCEPT OF TECHNOLOGY**
- **CREATE PARTNERSHIP AROUND THE WORLD**
- **IN A BUILDING AREA, reduce the charge load by applying the rec concept of building**

## Our Research and Conception

---

### REC BRICK

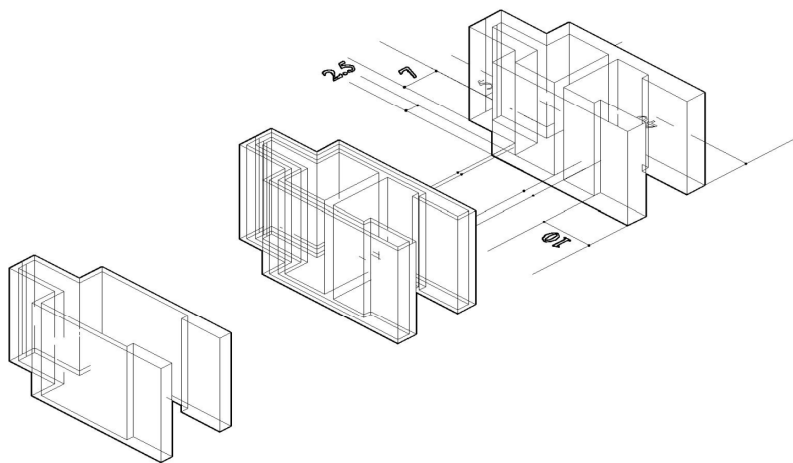

**Mr. Kennedy F. Tumenta**

**Founder CEO/AfricanBIB**

**[www.africanBIB.com](http://www.africanBIB.com)**

**[TFkennedy@africanBIB.com](mailto:TFkennedy@africanBIB.com)**

**Topic:**

**Promoting Ethical entrepreneurship  
and transfer of Integral knowledge**



## How the perception of “risk” influences investment in Africa

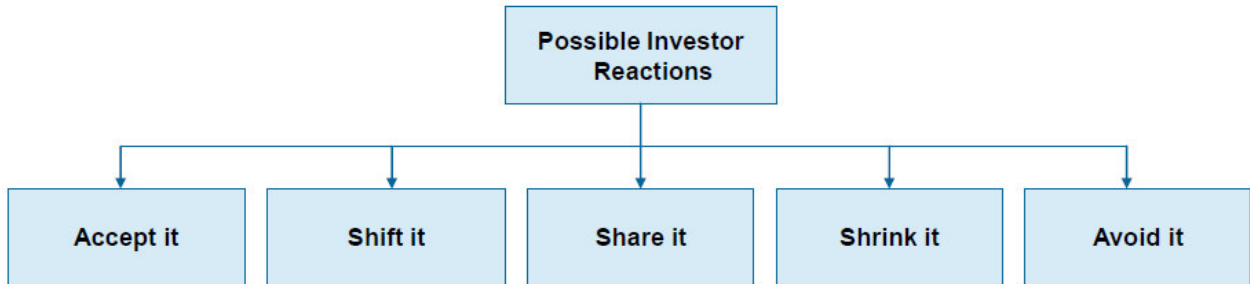
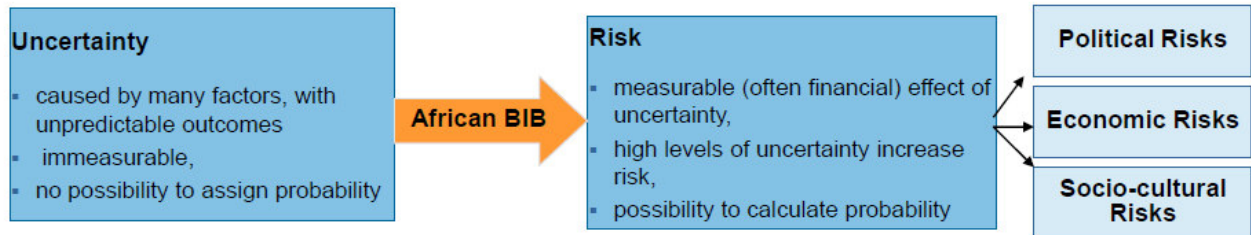

## Understanding the paradox of abundant business opportunity and investor reluctance within African markets

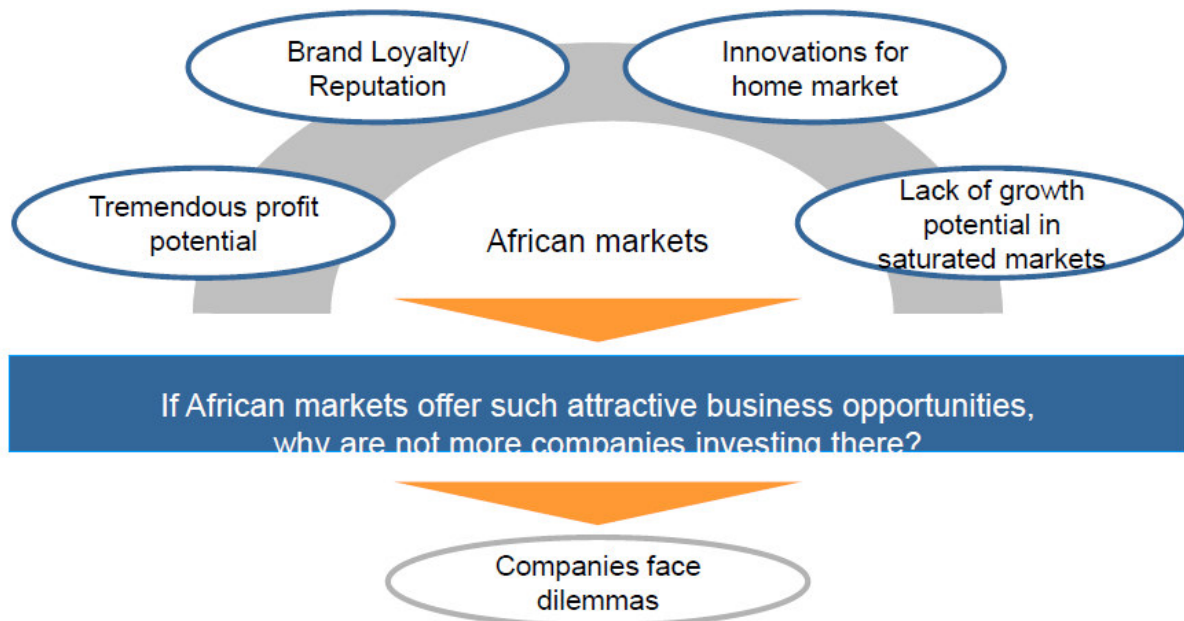

## Companies face different dilemmas that prevent them from not investing in African markets

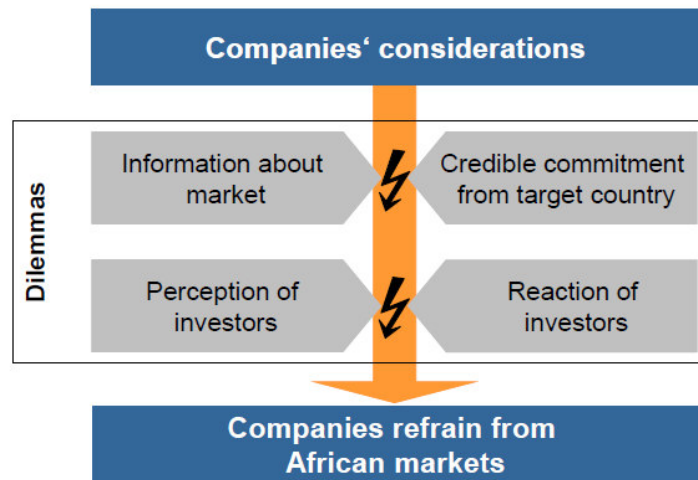

## Better understanding the dilemmas hindering investment by analyzing trends within African economies

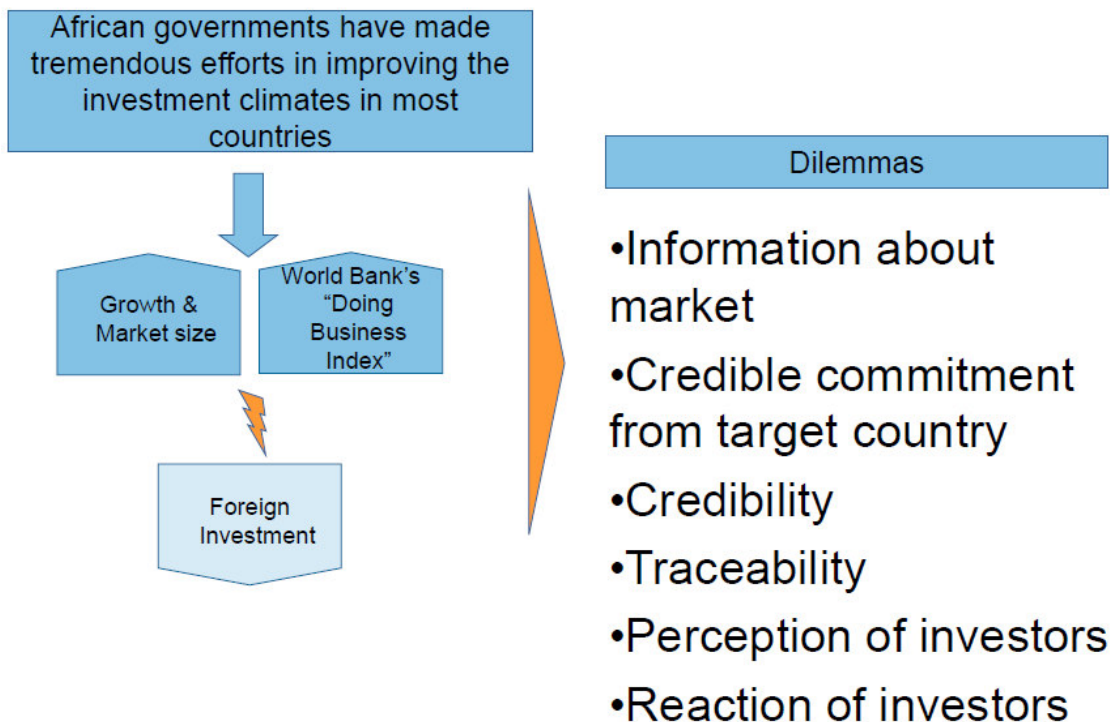

# AfricanBIB: a solution to one-sided dilemma-Structure. A mechanism for generating self-commitment

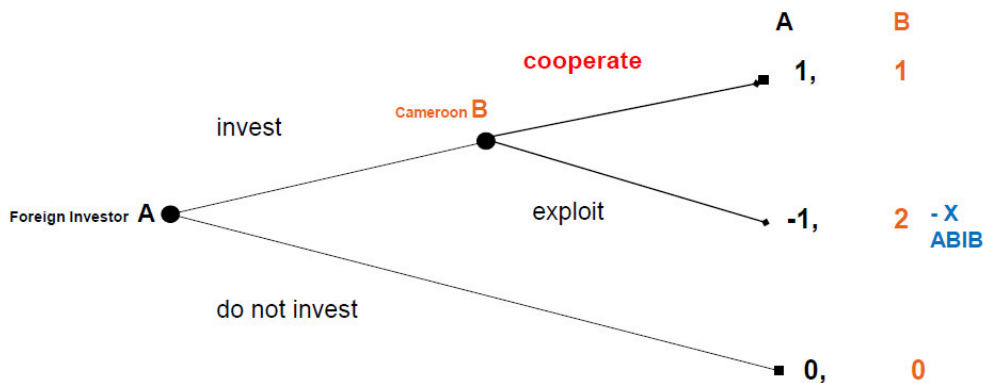

If A anticipates B's behavior, B has an incentive to find credible ways of **self-commitment** in order to realize gains from cooperation ((1, 1) instead of (0, 0))

**ABIB- X= Traceability, Credibility, Reputation, Certification, Real time Monitoring, using local specific Hold-up (peer monitoring) mechanism**

The Vision of the AfricanBIB is to be the leading provider of independent, accurate, timely, actionable and credible information of investment opportunities and possibilities of African SMMEs, NGOs, African Diasporas, and partners, as well as to bridge the information gap between potential investors and African businesses.

### Objective

African BIB has as one of its key objectives to transform investor's **uncertainty perception** into **manageable risk** and communicating these in ways that the long term perceptions of investors and African businesses/organizations are positively altered.

### Proposal

The AfricanBIB will bridge the information and knowledge gap that exists between potential investors, partners and African business operators by:

- Providing independent, credible, accurate, timely and actionable information on African countries investment opportunities to potential investors and partners
- Empowering African SMMEs to understand, prepare and present relevant business information in ways that are transparent to both African and foreign partners/investor
- Providing ratings/rankings for businesses, investment opportunities
- Building an operational exchange platform for B2I (I-Investor) and B2B
- Fostering sustainable entrepreneurship opportunities at the grassroots
- Providing investment funds for credible businesses and bankable opportunities

Mr. Kenndy F. Tumenta AfricanBIB

In order to provide an independent accurate, complete and actionable information, African BIB is creating information partnerships, harnessing local expertise and mastering the information lifecycle.

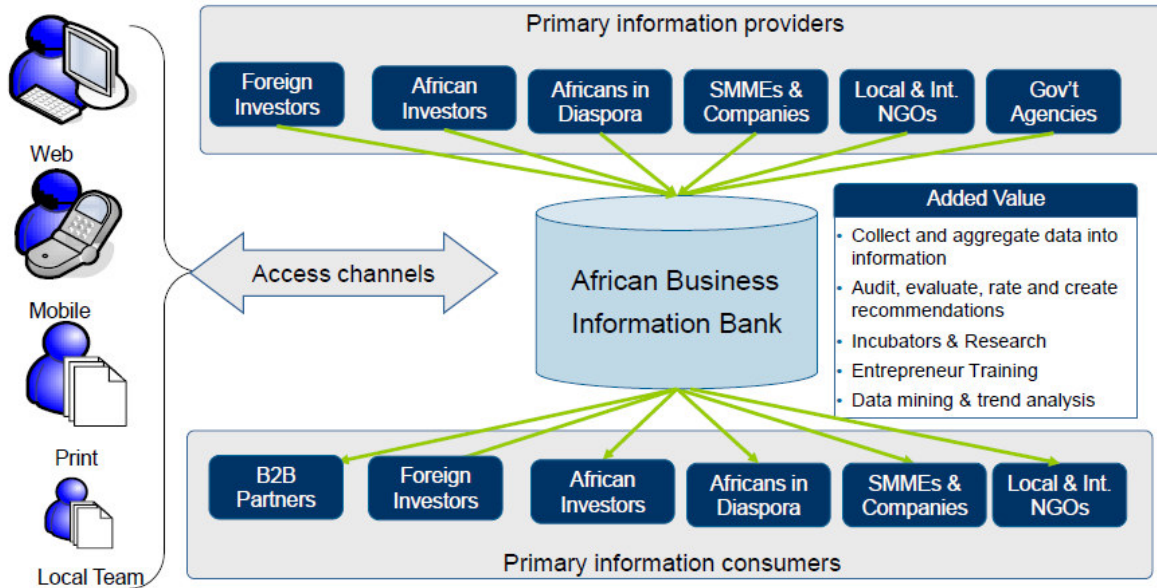

- Primary information providers offer information that is catalogued, rated, formatted and stored for access by the primary consumers.
- This information is accessible by mobile phones, Internet and print media to African and foreign investment community

ABIB- Information Screening & Verification Process

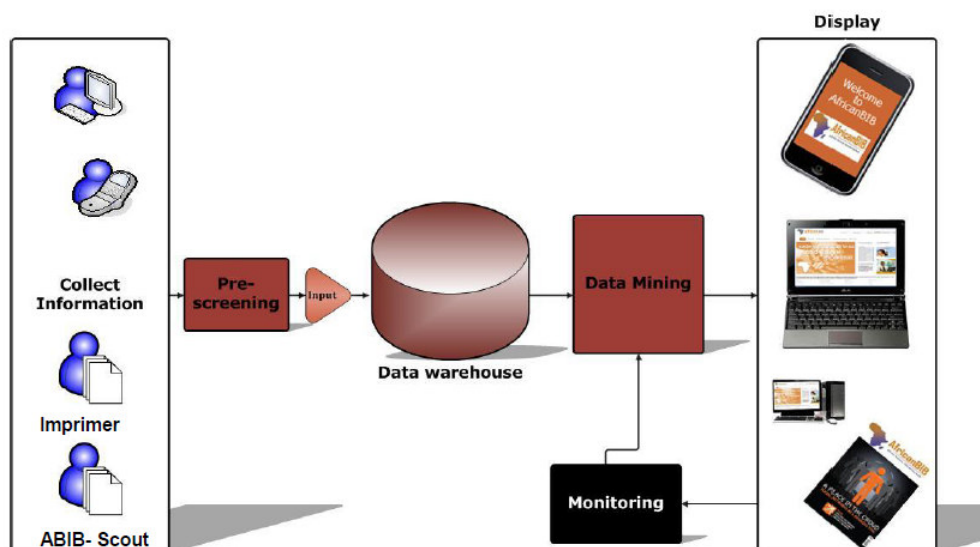

Mr. Kennedy F. Tumenta AfricanBIB

# How the perception of “risk” influences investment in Africa

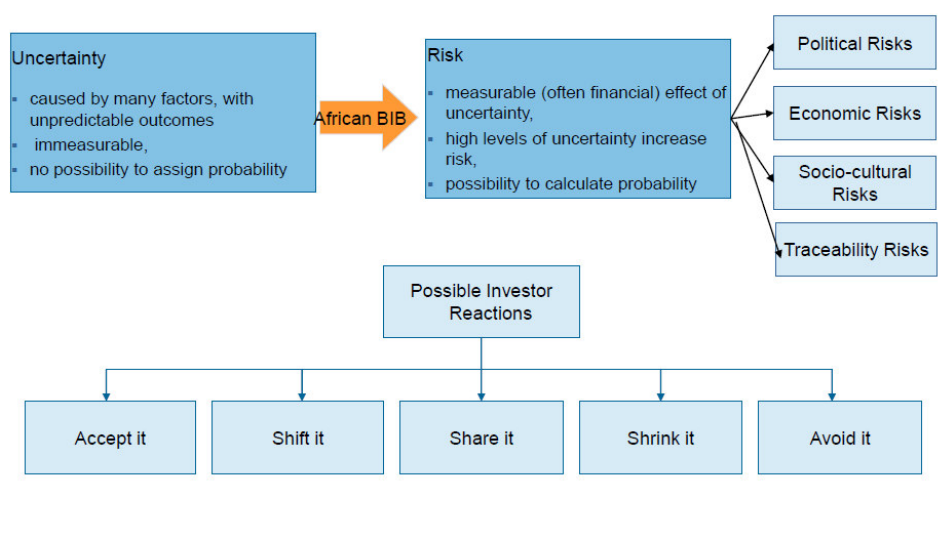

# Evolution of AfricanBIB Value Added services

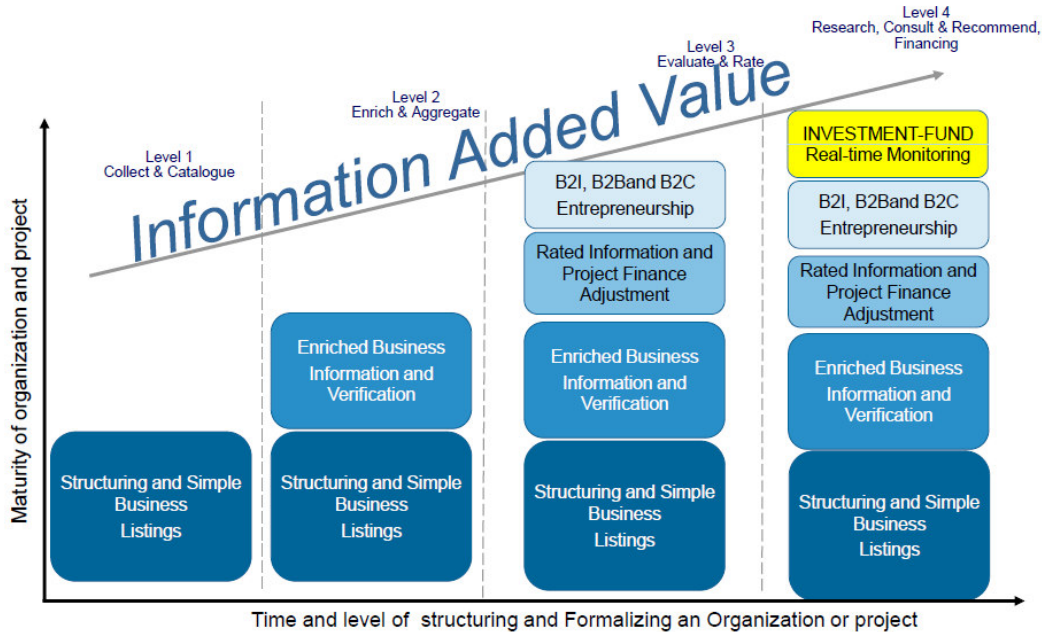

Mr. Kennedy F. Tumenta AfricanBIB



Engr. Stephane Ekobo  
Diasporex Group  
[contact@diasporex.org](mailto:contact@diasporex.org)  
Topic: Diasporex





**ASSOCIATION  
DIASPOREX**  
Une diaspora soudée

**Zoom sur le projet  
TECHNOREX 2014**  
"La technologie, une arme pour  
décupler la performance des  
organisations camerounaises"

## DIASPOREX



Une association régie par la loi du 1er Juillet 1901

Identification R.N.A. : W921003464  
No de parution : 20130043

Composée de talents issus de grandes écoles et universités et intervenant partout dans le monde dans des environnements à haute compétitivité et qui souhaitent créer de la valeur partout où ils sont à travers la mise en place d'un réseau dynamique qui véhicule des informations de qualité

L'échange et le partage pour progresser ensemble



DIASPOREX

diasporex

## Les missions de DIASPOREX

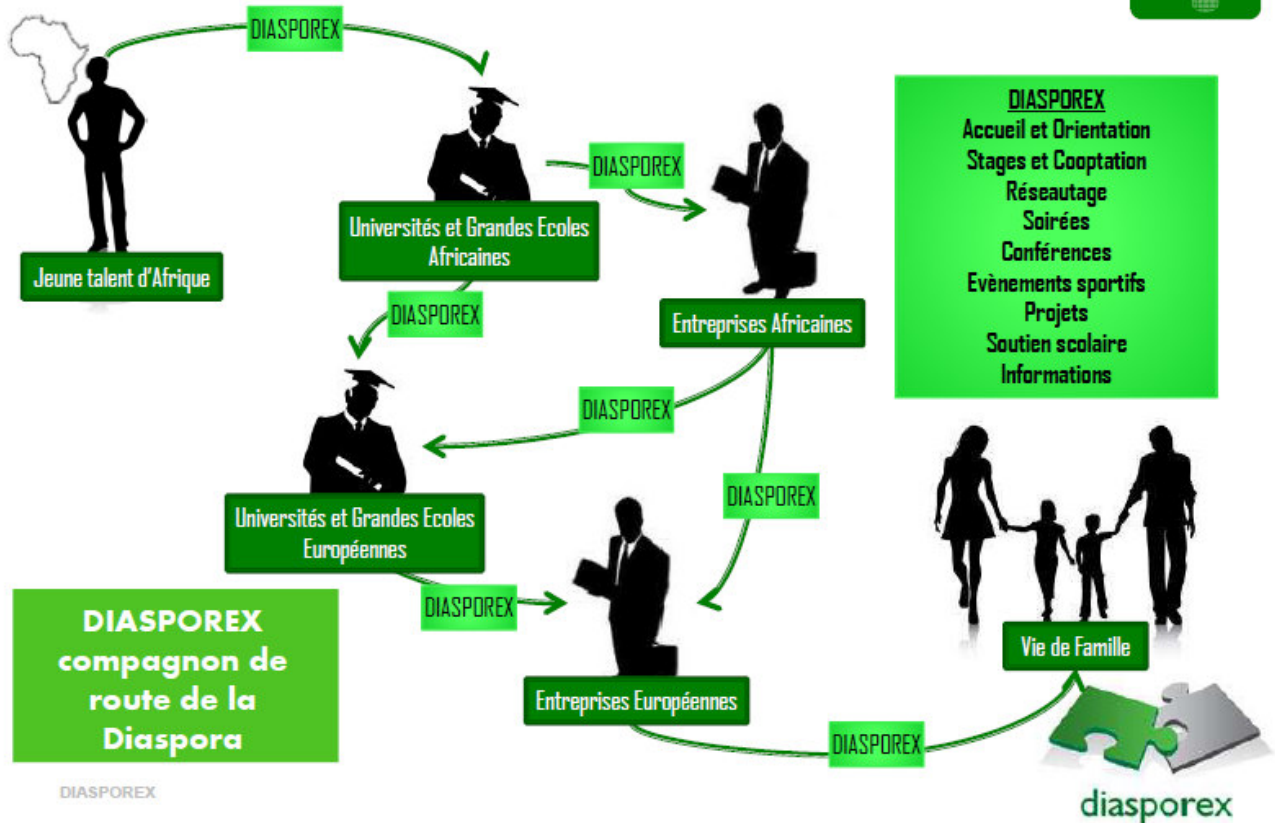

Engr. Stéphane Ekobo

## Les missions de DIASPOREX



- Participer à l'émergence des pays du sud
- Favoriser l'entrepreneuriat en encourageant la création de start-up
- Accueillir et orienter les talents africains pour une meilleure intégration dans leurs pays de destination
- Disposer d'un réseau de compétences ultra-réactif capable d'apporter des solutions au quotidien à ses membres
- Permettre à ses membres de voir leurs projets se concrétiser à travers l'apport de son réseau de compétences
- Faire du lobbying auprès de tous les acteurs de la société civile afin de donner à nos idées un écho
- Regrouper la diaspora des grandes écoles et des universités

DIASPOREX



## Les projets en cours



DIASPOREX



**TECHNOREX**



# Zoom sur la Conférence TECHNOREX 2014

TECHNOREX



**Le saviez-vous?**



L'ambition affichée de notre pays sur la scène mondiale  
**"Devenir un pays émergent d'ici 2035"**

Source : FMI

**Pays émergents aujourd'hui : Brésil, Russie,  
Inde, Chine, Afrique du Sud, Mexique,  
Indonésie...**

**Imaginez l'ampleur de la tâche !**

TECHNOREX



## Et ça bouge ...



## Croissance nette du PIB depuis 2009...

Tableau du texte 2. Cameroun: Contribution des secteurs à la croissance du PIB, 2006-12  
(En pourcentage)

	2006	2008	2009	2010	2011	2012
Secteur primaire	0.6	1.9	0.6	1.4	0.7	0.9
Secteur secondaire, hors pétrole	0.0	0.4	0.1	0.7	0.7	0.7
Secteur pétrolier	0.5	-0.1	-0.8	-0.6	-0.3	0.1
Secteur tertiaire	2.1	1.4	2.0	1.8	3.0	2.7
<b>Croissance du PIB réel</b>	<b>3.2</b>	<b>3.6</b>	<b>1.9</b>	<b>3.3</b>	<b>4.1</b>	<b>4.4</b>

Sources: autorités camerounaises.

TECHNOREX



## Cependant, des résultats insuffisants...



D'après les experts la croissance devrait être quasiment doubler chaque année pour que le Cameroun réalise son ambition!

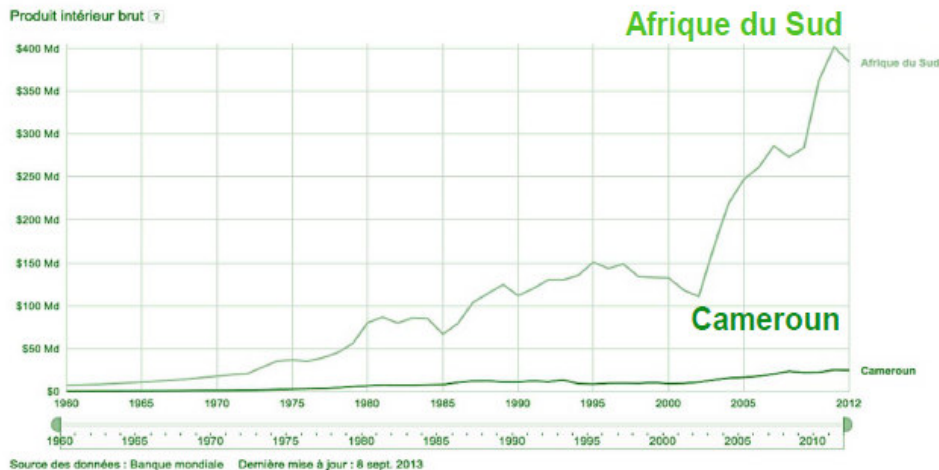

TECHNOREX



Engr. Stéphane Ekobo

# Entreprendre devient simple



Grâce aux efforts de l'état

**TABLEAU 2.1** Où est-il le plus facile dans l'espace OHADA de créer une entreprise et où est-ce le plus difficile ?

Procédures (nombre)			
Plus petit nombre		Plus grand nombre	
Burkina Faso	3	Côte d'Ivoire	10
Sénégal	3	Comores	11
Mali	4	Tchad	11
Cameroon	5	Guinée	12
Bénin	6	Guinée équatoriale	21

Délai (jours)			
Le plus court		Le plus long	
Sénégal	5	Gabon	58
Mali	8	Tchad	66
Guinée-Bissau	9	Togo	84
Burkina Faso	13	Guinée équatoriale	137
Cameroon	15	Congo, Rép. du	160

Coût (% du revenu par habitant)			
Le moins élevé		Le plus élevé	
Gabon	17,3	Bénin	149,9
Cameroon	45,5	République centrafricaine	175,5
Burkina Faso	47,7	Comores	176,2
Guinée-Bissau	49,8	Togo	177,2
Sénégal	68,0	Tchad	208,5

Source : base de données Doing Business.

**Le Cameroun fait partie des pays où il est le plus facile de créer une entreprise !!!**

Source : Publication Banque Mondiale, Doing Business in OHADA

TECHNOREX



# Malgré les nombreux obstacles



Des problèmes qui sont en fait de nombreuses opportunités

**Graphique III.4. Cameroun: principaux obstacles à l'activité économique**  
(Pourcentage des réponses)

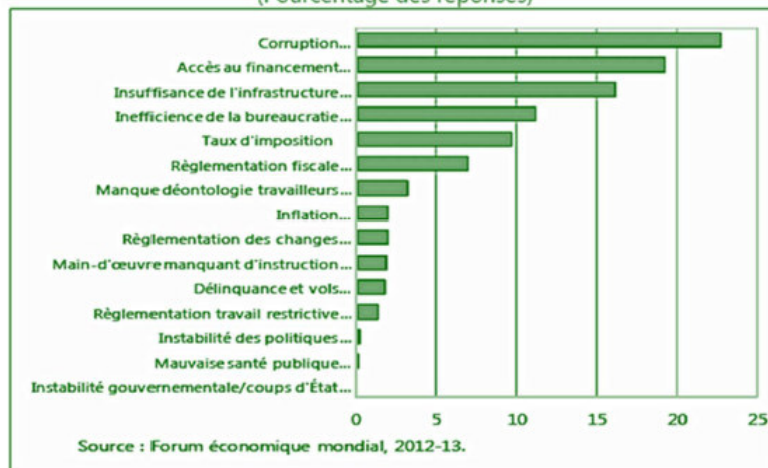

Source : Forum économique mondial, 2012-13.

TECHNOREX

Quelle est la contribution de Diasporex face à ces défis ?



Engr. Stéphane Ekobo

## Que pouvons nous faire?



un principe

**Chacun doit tout simplement y mettre du sien**

« Nous sommes des experts qui agissent au quotidien dans des environnements de haute compétitivité. »

« Nous souhaitons aussi apporter notre contribution pour aider au redressement des indicateurs de croissance de notre pays. »

TECHNOREX



## Conférence TECHNOREX 2014



### TECHNOREX 2014

**LA TECHNOLOGIE, UNE ARME POUR DECUPLER  
LA PERFORMANCE DES ORGANISATIONS  
CAMEROUNAISES**

**anticiper – innover – rationaliser**

TECHNOREX



Engr. Stéphane Ekobo

## Conférence TECHNOREX 2014



Des thèmes sur des solutions concrètes  
et activables immédiatement !



TECHNOREX



## TECHNOREX 2014



Des objectifs chiffrés pour le Cameroun en 2014

- Faire venir 15 experts dans les technologies clefs pour faire des retours d'expériences au Cameroun
- Attirer 10 projets de Développement offshore au Cameroun
- Former 200 Experts en gestion de contenus au Cameroun à un prix défiant la concurrence
- Former 200 Experts en sécurité des systèmes d'information Cameroun à un prix défiant la concurrence
- Faciliter l'implantation de 2 centres d'appels offshore au Cameroun
- Faire migrer 10 PME camerounaises vers le Cloud

TECHNOREX



Engr. Stéphane Ekobo



## TECHNOREX 2014



### Retombées pour le Cameroun

- Faire du Cameroun une plateforme de référence technologique en Afrique
- Faire du Cameroun un partenaire privilégié des investisseurs étrangers dans les domaines technologiques

TECHNOREX



## Agenda DIASPOREX 2014



- Partenariat avec l'ambassade du CM à Paris : **05/2014**
- Challenge Camerounais de Dortmund : **06/2014**
- Conférence « Achat Logement » : **09/2014**
- Diner « Tutorat et Parrainage » : **10/2014**
- Soirée Annuelle DIASPOREX : **12/2014**
- Assemblée Générale Ordinaire : **12/2014**

Engr. Stéphane Ekobo

## Round Table

# Commitment of the African Engineers & Scientists to catalyse the Technology Transfer: The challenges

**Panellists: Stéphane Ekobo; Aristide Baho; Benjamin Boum**

**Moderation: Vox africa**



## Some highlights of the round table

**Engr. Stephane Ekobo, Diasporex, Orange France**



La technologie en elle même est un levier immense pour la croissance d'un pays. Quand une idée technologique innovante arrive sur le marché, elle peut créer le business. La technologie n'est pas quelque chose de simple. Trouver une méthode pour se l'appropriier correctement et pouvoir la mettre au service de la création des valeurs dans notre pays

**Benjamin Boum, Mathématicien, Enseignant**



Je pense qu'il ya un réel problème dans notre pays en particulier et en Afrique en général. Il ya des camerounais qui essaient à partir de l'extérieur de se battre pour le développement de notre pays, mais il n'y arrivent pas. Je crois que c'est là où il faut poser le problème. Pourquoi n'arrive t'on pas à décoller ? Avons-nous absolument besoin de ceux de l'extérieur ? Si on n'avait que ceux qui sont au pays, ils ne pouvaient pas développer cette nation ou cette Afrique ? je suis convaincu que nous devons d'abord voir les conditions, l'atmosphère, ce qui nous entoure pour comprendre quelle est la force que nous devons mettre lorsque nous devons nous engager dans un transfert de technologie



**Aristide Baho, Informaticien, Enseignant**



Les ingénieurs nationaux en principe devraient orienter la maîtrise de la technologie vers les couches défavorisées. Qu'est ce que ces ingénieurs peuvent nous apporter quand on se rend compte que 50 ans après les indépendances, nous soyons encore à importer les fers à repasser, le matériel nécessaire pour nos ménages ! On se demande à quoi servent nos ingénieurs ? Ne sont t'ils la que pour travailler pour les autres ? Que peuvent t'ils produire ? Va t'on directement jeter la pierre sur les ingénieurs ? Non car il faut se poser la question si les politiques intérieures incitent à la production. Aussi il faut orienter la formation vers l'auto emploi.

## Interview du Prof. Dr. Emmanuel Ngameni, Doyen de la faculté des sciences de l'université de Dschang

L'homme ingénieur, l'homme scientifique à la technicité et il a le devoir de passer de sa connaissance théorique, livresque à ce qui est pratique, à ce qui peut être utilisé, à ce qui peut être mis au profit du quotidien de ses concitoyens.

Certes, le politique à la charge de l'orientation. Mais nous ne pouvons pas nous dédouaner en permanence sur le politique. Nous pouvons faire chacun où il se trouve ce qu'il doit faire. Montrer que la mathématique, la physique, la chimie qui a été apprise n'est pas un concept éthéré, mais que cela peut servir résoudre les problèmes quotidiens.



## Some pictures of the conference



## Some pictures of the conference





**Conference: PKFokam Institute of Excellence  
Yaoundé – Cameroon (EMANA)**

**July 18 - 19, 2014**

**TOPIC: “The Conquest and Development of Science and  
Technology”**

***Technology transfer in Africa? Sure! But how? That’s the  
question. Your opinion counts***

- *The objective of the conference is to bridge the gap between theory and practice*
- *It will therefore concentrate on aspects that are lacking in the promotion and development of activities relating to the field of Research, Science and Technology in Africa.*
- *Mechanical Engineering for the Supporting of Industrialization!*
- *Drug Development for the Supporting of the Health Sector!*
- *Software Engineering for the boosting of Services!*
- *Symbiosis between Engineers, Scientists, Industrialists, Financial institutions; in the Diaspora and inside the continent*

**[info@ruad-eurd.org](mailto:info@ruad-eurd.org)**

***Conference coordinator: Dr. Nestor Kamdem***

**[www.pkfinstitute.com](http://www.pkfinstitute.com) [pkfokam@pkinstitute.com](mailto:pkfokam@pkinstitute.com) Tel: 22019027**

***Welcome***



PKfokam Institute of Excellence

P.O. Box: 11646 Yaoundé/Cameroon

Tel: +(237) 222 01 90 27

pkfokam@pkinstitute.com

***www.pkfinstitute.com***